

Track System Specification

S40HP

— TLS-S40 series



【Basic Parameters】

- Material: AL6063-T5, spraying surface
- Coating: Black (RAL9005), White(RAL9003)
- Length: 600mm/1200mm/1500mm /1800mm/2400mm optional
- IP grade: IP20
- CCT: 2700/3000/3500/4000/5000/6500/3000-6500K optional
- CRI: 80/90
- SDCM: <3 Step (ANSI)
- Beam angle: 60°x75°
- U G R: UGR≤19(X=4H,Y=8H)
- Light efficiency: 75 lm/W
- Input voltage: AC200-240V
- Lighting direction: downward
- Dimming method: Non /1-10V / DALI+push optional
- Application: Indoor
- Certification: CE, UKCA, ROHS, Reach
- Warranty: 5 years

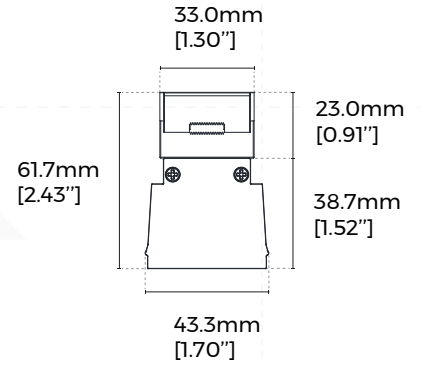
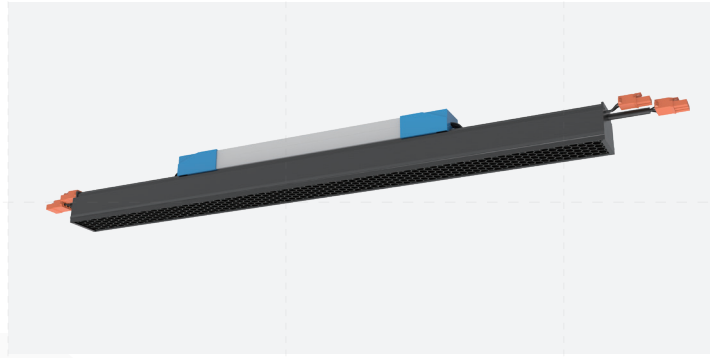

【Luminaire Parameters】

Version	Model	Length	Input Voltage (V)	Max. Current (A)	Type Power (W)	Max. Power (W)	Beam Angle (°)	CRI	CCT	Lumen (LM)
Normal	S40HP	600mm [1.97ft]	200-240 VAC	0.09 [0.05A/ft]	17 [8.63W/ft]	18.7 [9.49W/ft]	60°x75°	>80	2700K	1185 [600LM/ft]
									3000K	1210 [615LM/ft]
									3500K	1235 [630LM/ft]
									4000K	1275 [645LM/ft]
									5000K	1275 [645LM/ft]
									6500K	1275 [645LM/ft]
								>90	2700K	1020 [520LM/ft]
									3000K	1040 [530LM/ft]
									3500K	1065 [540LM/ft]
									4000K	1095 [555LM/ft]
									5000K	1095 [555LM/ft]
									6500K	1095 [555LM/ft]

Normal	S40HP	1200mm [3.94ft]	200-240 VAC	0.18 [0.05A/ft]	34.0 [8.63W/ft]	37.4 [9.49W/ft]	60°x75°	>80	2700K	2370 [600LM/ft]
									3000K	2425 [615LM/ft]
									3500K	2475 [630LM/ft]
									4000K	2550 [645LM/ft]
									5000K	2550 [645LM/ft]
									6500K	2550 [645LM/ft]
		>90		2700K	2040 [520LM/ft]					
				3000K	2085 [530LM/ft]					
				3500K	2125 [540LM/ft]					
				4000K	2195 [555LM/ft]					
				5000K	2195 [555LM/ft]					
				6500K	2195 [555LM/ft]					
	>80	1500mm [4.92ft]	0.24 [0.05A/ft]	46.0 [9.35W/ft]	50.6 [10.29W/ft]	>80		2700K	3210 [650LM/ft]	
								3000K	3280 [665LM/ft]	
								3500K	3345 [680LM/ft]	
								4000K	3450 [700LM/ft]	
								5000K	3450 [700LM/ft]	
								6500K	3450 [700LM/ft]	
	>90	1800mm [5.91ft]	0.26 [0.05A/ft]	51.0 [8.63W/ft]	56.1 [9.49W/ft]	>90		2700K	2760 [560LM/ft]	
								3000K	2820 [575LM/ft]	
								3500K	2880 [585LM/ft]	
								4000K	2965 [605LM/ft]	
								5000K	2965 [605LM/ft]	
								6500K	2965 [605LM/ft]	
>80	1800mm [5.91ft]	0.26 [0.05A/ft]	51.0 [8.63W/ft]	56.1 [9.49W/ft]	>80	2700K	3555 [600LM/ft]			
						3000K	3635 [615LM/ft]			
						3500K	3710 [630LM/ft]			
						4000K	3825 [645LM/ft]			
						5000K	3825 [645LM/ft]			
						6500K	3825 [645LM/ft]			
>90	1800mm [5.91ft]	0.26 [0.05A/ft]	51.0 [8.63W/ft]	56.1 [9.49W/ft]	>90	2700K	3060 [520LM/ft]			
						3000K	3125 [530LM/ft]			
						3500K	3190 [540LM/ft]			
						4000K	3290 [555LM/ft]			
						5000K	3290 [555LM/ft]			
						6500K	3290 [555LM/ft]			

Normal	S40HP	2400mm [7.87ft]	200-240 VAC	0.35 [0.05A/ft]	68.0 [8.64W/ft]	74.8 [9.50W/ft]	60°x75°	>80	2700K	4745 [605LM/ft]					
									3000K	4845 [615LM/ft]					
									3500K	4945 [630LM/ft]					
									4000K	5100 [650LM/ft]					
									5000K	5100 [650LM/ft]					
									6500K	5100 [650LM/ft]					
								>90	2700K	4080 [520LM/ft]					
									3000K	4165 [530LM/ft]					
									3500K	4255 [540LM/ft]					
									4000K	4385 [555LM/ft]					
									5000K	4385 [555LM/ft]					
									6500K	4385 [555LM/ft]					
Dial switch CCT tunable	S40HP	600mm [1.97ft]	200-240 VAC	0.09 [0.05A/ft]	17.0 [8.63W/ft]	18.7 [9.49W/ft]	60°x75°	>80	3000K	1240 [630LM/ft]					
									4300K	1290 [655LM/ft]					
									6500K	1260 [640LM/ft]					
								>90	3000K	1065 [540LM/ft]					
									4300K	1110 [565LM/ft]					
									6500K	1080 [550LM/ft]					
		1200mm [3.94ft]						200-240 VAC	0.18 [0.05A/ft]	34.0 [8.63W/ft]	37.4 [9.49W/ft]	60°x75°	>80	3000K	2480 [630LM/ft]
														4300K	2585 [655LM/ft]
														6500K	2515 [640LM/ft]
													>90	3000K	2135 [540LM/ft]
														4300K	2220 [565LM/ft]
														6500K	2165 [550LM/ft]
1500mm [4.92ft]	200-240 VAC	0.23 [0.05A/ft]	46.0 [9.35W/ft]	50.6 [10.29W/ft]	60°x75°	>80	3000K						3360 [685LM/ft]		
							4300K						3495 [710LM/ft]		
							6500K						3405 [690LM/ft]		
						>90	3000K						2890 [585LM/ft]		
							4300K						3005 [610LM/ft]		
							6500K						2925 [595LM/ft]		
1800mm [5.91ft]						200-240 VAC	0.26 [0.05A/ft]	51.0 [8.63W/ft]	56.1 [9.49W/ft]	60°x75°	>80	3000K	3725 [630LM/ft]		
												4300K	3875 [655LM/ft]		
												6500K	3775 [640LM/ft]		
											>90	3000K	3200 [540LM/ft]		
												4300K	3335 [565LM/ft]		
												6500K	3245 [550LM/ft]		

Dial switch CCT tunable	S40HP	2400mm [7.87ft]	200-240 VAC	0.35 [0.05A/ft]	68.0 [8.64W/ft]	74.8 [9.50W/ft]	60°x75°	>80	3000K	4965 [630LM/ft]
									4300K	5170 [655LM/ft]
									6500K	5030 [640LM/ft]
								>90	3000K	4270 [540LM/ft]
									4300K	4445 [565LM/ft]
									6500K	4330 [550LM/ft]

Note:

1. The output data is based on the testing result of Ra80,4000k,white luminaires;
2. The tolerance of output data can be vary up to 10%;
3. The output data is typical value;
- 4.The luminous flux of silver luminaire is the same as that of white luminaire, while the luminous flux of black luminaire is 55% of white luminaire.

【Optical Parameter】

[Normal/Emergency]

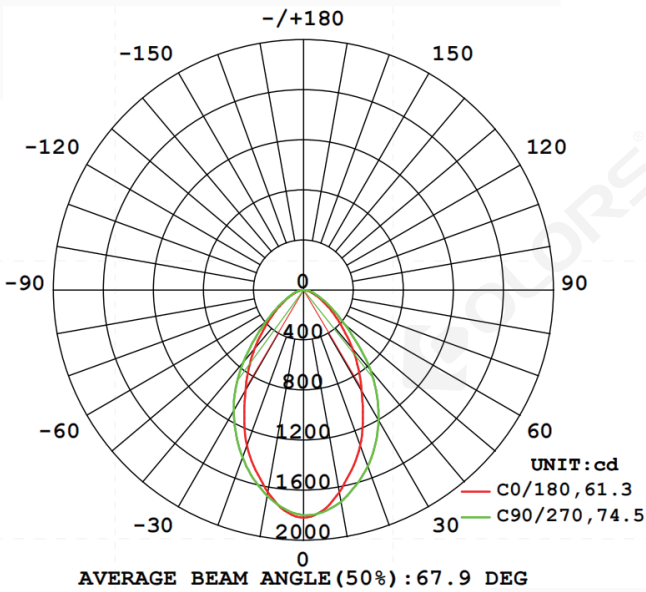

Luminous intensity
distribution diagram

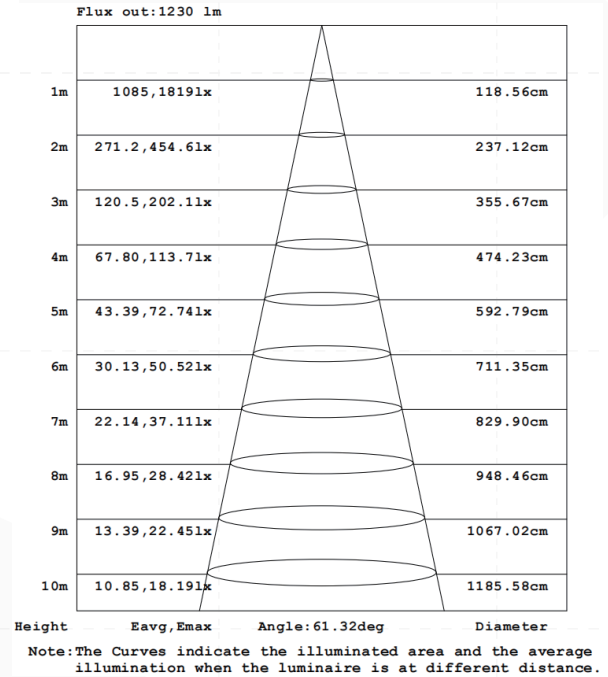

AAI Figure

[Dial switch CCT tunable]

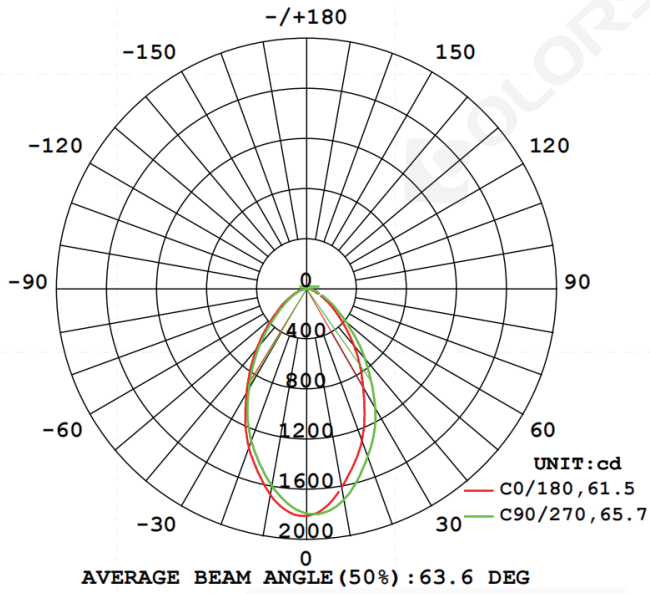

Luminous intensity distribution diagram

Flux out: 1180 lm

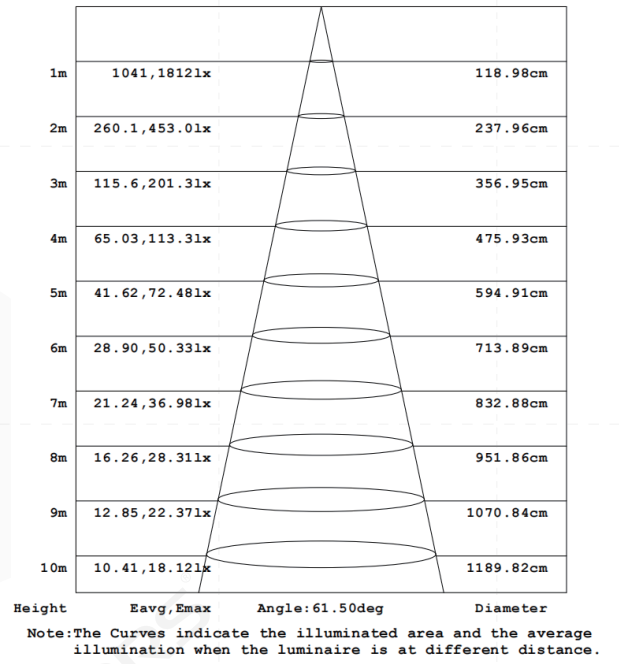

AAI Figure



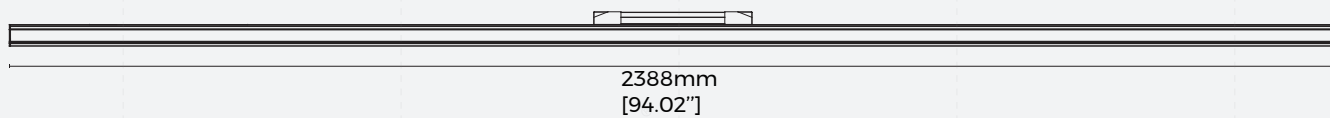
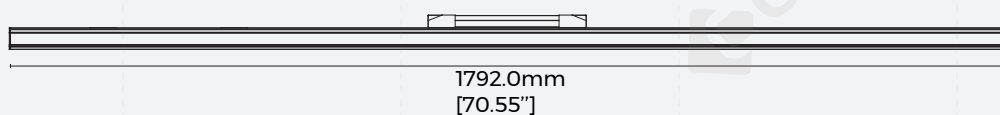
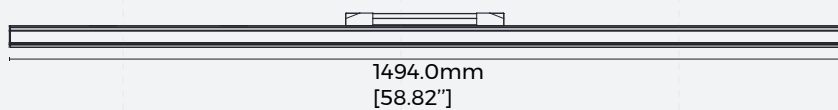
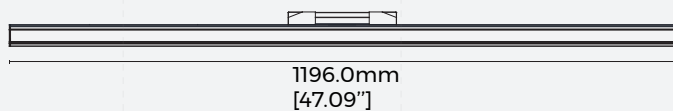
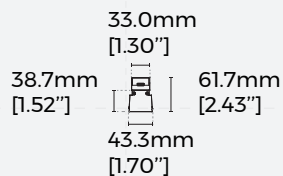
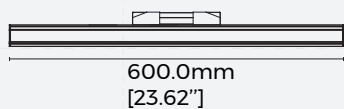







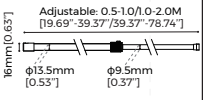

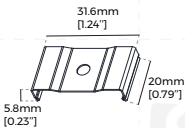



[Product mechanical data]

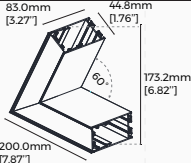

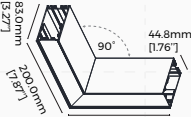
Note: Module length shown above indicates the length of profile + thickness of 2 end caps, where each end cap is 2mm thick, 2 end caps is 4mm thick in total.

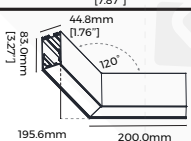
[Product Accessories Information]

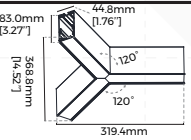
Picture	Section size	Name	Description	Model	Note
		Presence sensing module	Input:220-240V AC 50Hz/60Hz; Output max:800W; Hold time:5S/30S/90S/ 5Min/20Min/30Min Detection Area:100%/75%/50% /25% Daylight Sensor:2lux/10lux/ 30lux/50lux/Disable Detecting Radius:4-6m (mounting height 3m) Mounting Height:2.5-6 m Detecting Angle:150° Size:L304.0*W43.2*H40.1mm [Inch Size:L11.97"*W1.70"*H1.58"]	CS-S40	/
		Track	Material:AL6063-T5 Surface processing:Spraying Size:L2500*W45*H83mm [Inch size:L98.43"*W1.77"*H3.27"]	PR-LS40	Pendant / Ceiling track
		Track cover	Material:AL6063-T5 Surface processing:Spraying Size:L2500*W42.6*H29.6mm [Inch size:L98.43"*W1.68"*H1.17"]	CV-S40FB	Track accessory
	/	Flexible Diffuser	Material:PC Light transmittance:≥75% Size:L20000/50000*W37.8* H6.7mm [Inch size:L787.4/1968.5"*W1.49"* H0.26"]	CV-LS40FD	Diffuser accessory
		Track end cap	Material:AL6063-T5 Surface processing:Spraying Size:L83*W45*H10.5mm [Inch size:L3.27"*W1.77"*H0.41"]	EC-LS40	End acp accessories
		Track cover end cap	Material:AL6063-T5 Surface processing:Spraying Size:L42.6*W22.7*H2.0mm [Inch size:L1.68"*W0.89"*H0.08"]	EC-S40	
		Splicing bar (external)	Size:L110*W15.5*H11.7mm [Inch size:L4.33"*W0.61"*H0.46"]	EX-41	Splicing accessories
		Splicing bar (internal)	Material:SPCC Size:L135*W41.4*H42.2mm [Inch size:L5.31"*W1.63"*H1.66"]	EX-46(N)	
	/	Pendant cable (with junction box)	Junction box L80*W80*H30mm [Inch Size:L3.15"*W3.15"*H1.18"] Steel cable D1.5*2000/4000mm [Inch Size: D0.06"*78.74"/157.48"]	PY-D	Pendant track installation accessory
	/	Pendant cable	Steel cable D1.5*2000/4000mm [Inch Size: D0.06"*78.74"/157.48"]	PN-D	

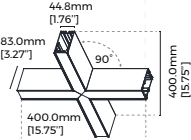
	 Adjustable: 0.5-1.0/1.0-2.0M [19.69"-39.37"/39.37"-78.74"] φ13.5mm [0.53"] φ9.5mm [0.37"] 16mm [0.63"]	Track pendant rod	Material:Fe Size:φ13.5*(500/1000)mm [Inch size:φ0.53***(19.69"/39.37")] Other:0.5-1.0/1.0-2.0M adjustable [19.69"-39.37"/39.37"-78.74"]	PG-I	Pendant track installation accessory
	 31.6mm [1.24"] 20mm [0.79"] 5.8mm [0.23"]	Pendant installation clip	Material:PC Size:L31.6*W20mm*H5.8mm [Inch size:L1.24**H0.79**H0.23"]	CP-44	
	/	Surface mounted buckle	Size:L72*W54*H5.9mm (Inch Size:L2.83**W2.13**H0.23")	CL-08	Ceiling track installation accessory
	/	No Dimming line 1m/2m	Size:L72*W54*H5.9mm (Inch Size:L2.83**W2.13**H0.23")	1m: CM-11 2m: CM-13	Power feed cable
	/	Dimming line 1m/2m	Size:L72*W54*H5.9mm (Inch Size:L2.83**W2.13**H0.23")	1m: CM-12 2m: CM-14	
	/	2m 1-in-2-out power feed cable	Size:L72*W54*H5.9mm (Inch Size:L2.83**W2.13**H0.23")	CM-15	
	/	0.2m corner connection cable	Size:L72*W54*H5.9mm (Inch Size:L2.83**W2.13**H0.23")	CM-16	
	 83.0mm [3.27"] 44.8mm [1.76"] 173.2mm [6.82"] 200.0mm [7.87"]	L-shaped corner (60°)	Material:AL6063-T5 Size:L200*W173.2*H83.0mm [Inch size:L7.87**W6.82**H3.27"]	L60-LS40	
	 83.0mm [3.27"] 44.8mm [1.76"] 200.0mm [7.87"]	L-shaped corner (90°)	Material:AL6063-T5 Size:L200*W200*H83.0mm [Inch size:L7.87**W7.87**H3.27"]	L90-LS40	
	 83.0mm [3.27"] 44.8mm [1.76"] 195.6mm [7.70"] 200.0mm [7.87"]	L-shaped corner (120°)	Material:AL6063-T5 Size:L200*W195.6*H83.0mm [Inch size:L7.87**W7.70**H3.27"]	L120-LS40	Pendant / Ceiling track corner accessories
	 83.0mm [3.27"] 44.8mm [1.76"] 368.8mm [14.52"] 319.4mm [12.57"]	Y-shaped corner	Material:AL6063-T5 Size:L368.8*W319.4*H83.0mm [Inch size:L14.52**W12.57**H3.27"]	Y120-LS40	
	 44.8mm [1.76"] 83.0mm [3.27"] 400.0mm [15.75"]	X-shaped corner	Material:AL6063-T5 Size:L400*W400*H83.0mm [Inch size:L15.75**W15.75**H3.27"]	X90-LS40	

【Version Type】

【Normal】

- 75lm/W
- Dimming method: Non / 1-10V / DALI+push

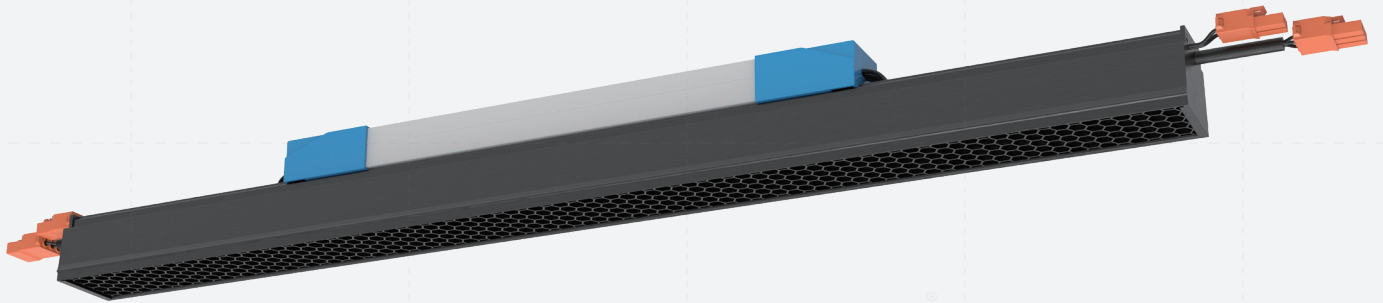

【Dial switch CCT control】

- Dimming method: Non/ 1-10V/ DALI+push optional
- 3000K/4300K/6500K 3-tier CCT adjustable, can achieve general lighting demands

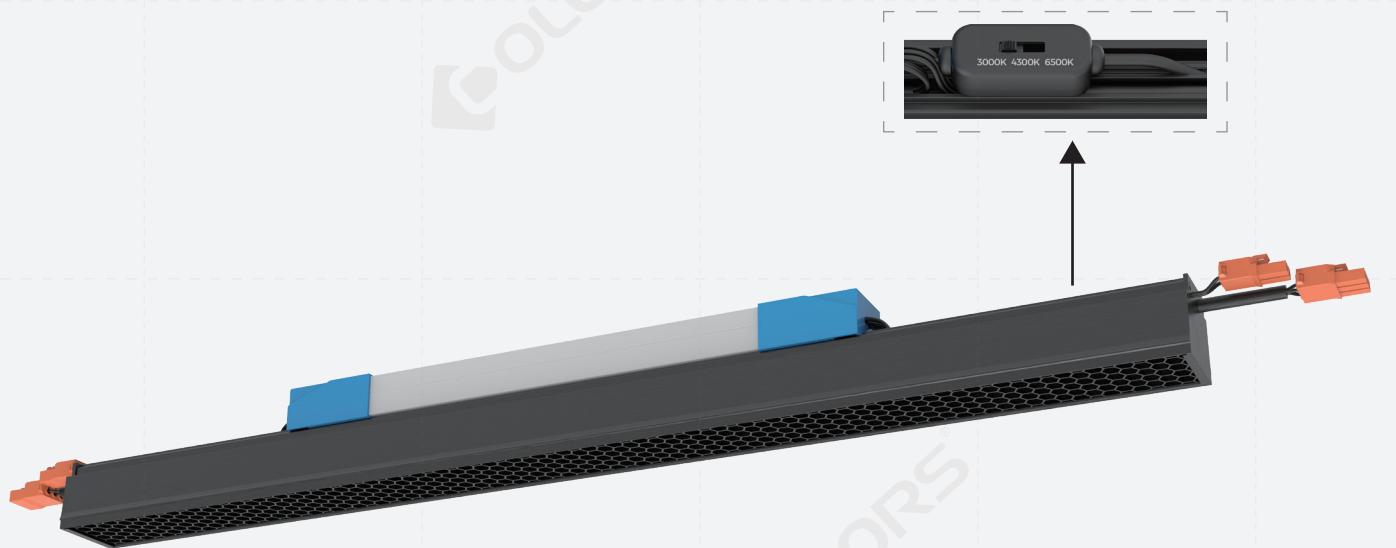

[Packing]

Model	Size (mm/box)	Quantity /box	Quantity /carton	NW (kg)	NW /carton/(kg)	GW (kg)	Size (mm/carton)
TLS-S40HPXBS0600(N)- T17NW8N-DC	760*70*55 [29.92"*2.76"*2.17"]	1	6	0.65	3.90	4.93	780*230*130 [30.71"*9.06"*5.12"]
TLS-S40HPXBS1200(N)- T34NW8N-DC	1356*70*55 [53.39"*2.76"*2.17"]	1	6	1.20	7.20	9.11	1376*230*130 [54.17"*9.06"*5.12"]
TLS-S40HPXBS1500(N)- T46NW8N-DC	1654*70*55 [65.12"*2.76"*2.17"]	1	6	1.50	9.00	11.39	1674*160*130 [65.91"*6.30"*5.12"]
TLS-S40HPXBS1800(N)- T51NW8N-DC	1952*70*55 [76.85"*2.76"*2.17"]	1	6	1.80	10.80	13.66	1972*160*130 [77.64"*6.30"*5.12"]
TLS-S40HPXBS2400(N)- T68NW8N-DC	2548*70*55 [100.31"*2.76"*2.17"]	1	6	2.40	14.4	18.22	2568*160*130 [101.10"*6.30"*5.12"]

[Attentions]

- 1、 Non-professionals are prohibited from installing, disassembling and repairing the product.
- 2、 Avoid scratching, distortion and irregular bending of the product during installation; otherwise it may cause irreparable damage to the product.
- 3、 Please use professional cutting tools when cutting.
- 4、 Do not use any acid or alkaline adhesive to fix products.
- 5、 The product is only suitable for indoor dry places, can not be used in outdoor, seaside or wet environment.
- 6、 PC features: Each 10°C rise or drop will make diffuser extend or shrink 0.8mm/m, please confirm before processing and use.